



EXCLUSIVE
2013 / 2014

COLOR



A1 MARS



Cleaning of glass



Fresh air connector

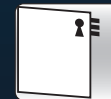

Three points closing

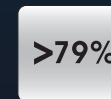

Efficiency

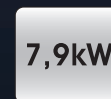

Heating power



Dimension of wood logs

Black, Serpentino

GREY



Serpentino



Yellow Sandstone



Silver Steel Sides



Vapnenac

BLACK



Granit



Yellow Sandstone



Serpentino



Vapnenac

TECHNICAL DATA

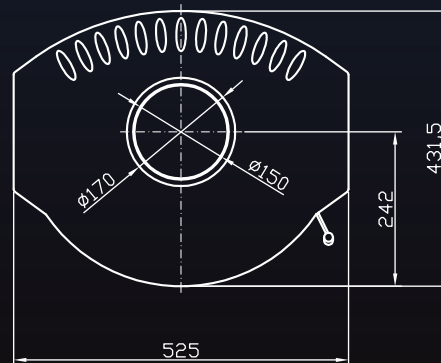
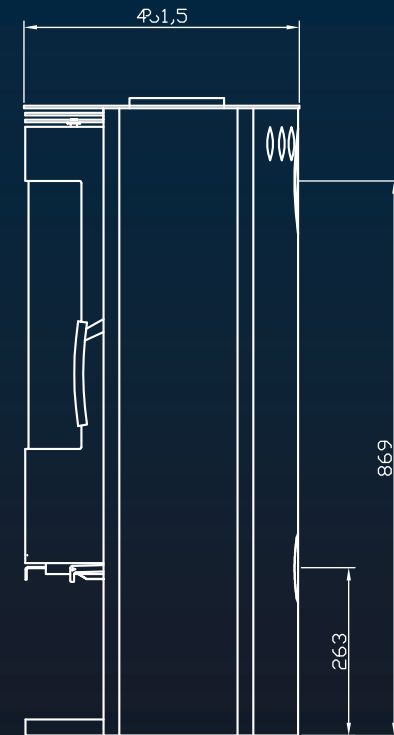
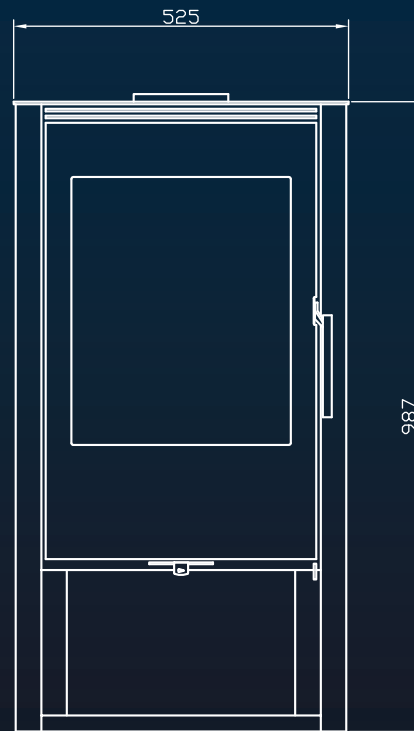

Nominal heating power:	7,9 kw
Room heating capacity:	40-120 m ²
Weight:	138 kg
Distance to combustible materials:	Back 200mm/Side 200mm/ Front 1000mm
Efficiency:	79,5%
Fine dust:	< 33 mg/m ³
Connection piece for Fresh Air:	intake Ø 100mm
Flue Pipe outlet diameter:	Ø150



A2 SATURN



Cleaning of glass



Fresh air connector

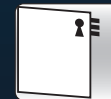

Three points closing

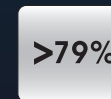

Efficiency

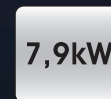

Heating power



Dimension of wood logs

Grey, Steel Sides

GREY



Serpentino



Yellow Sandstone



Silver Steel Sides



Vapnenac

BLACK



Granit



Yellow Sandstone



Serpentino



Vapnenac

TECHNICAL DATA

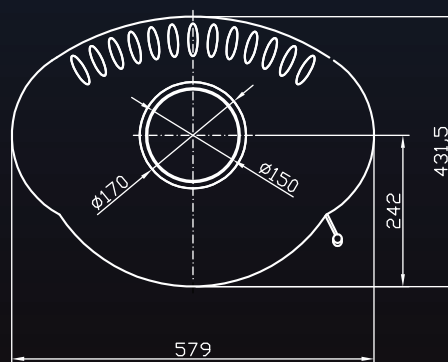
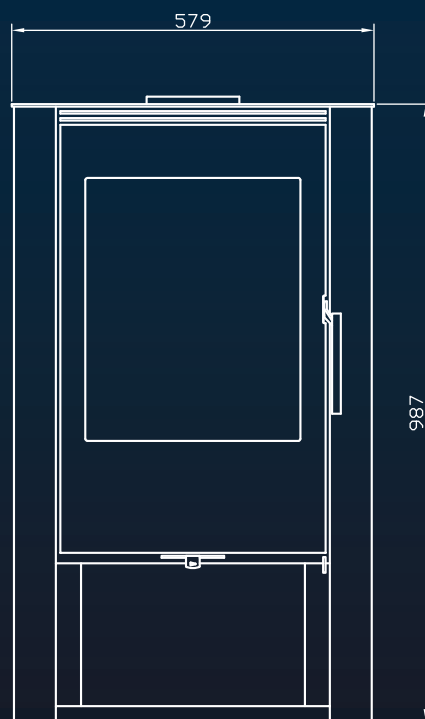

Nominal heating power:	7,9 kw
Room heating capacity:	40-120 m ²
Weight:	138 kg
Distance to combustible materials:	Back 200mm/Side 200mm/ Front 1000mm
Efficiency:	79,5%
Fine dust:	< 33 mg/m ³
Connection piece for Fresh Air:	intake ϕ 100mm
Flue Pipe outlet diameter:	ϕ 150

A3 ARENA



Cleaning of glass



Fresh air connector

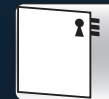

Three points closing

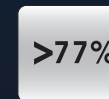

Efficiency

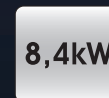

Heating power



Dimension of wood logs

Grey, Steel Sides



GREY



Serpentino



Yellow Sandstone



Granit



Vapnenac

BLACK



Granit



Yellow Sandstone



Serpentino



Vapnenac

TECHNICAL DATA

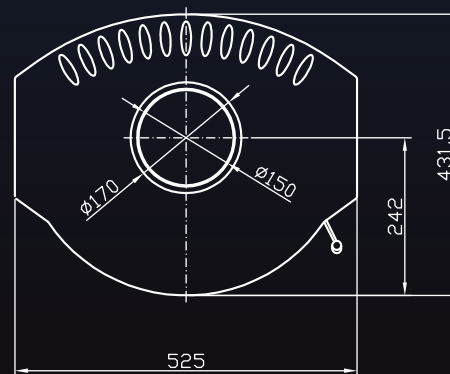
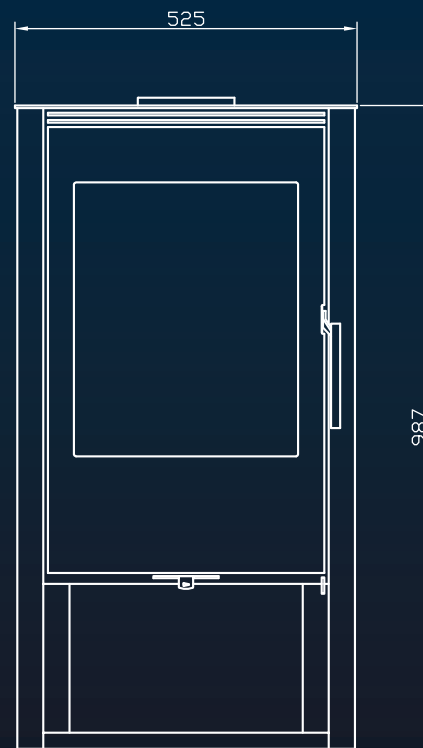

Nominal heating power:	8,4 kw
Room heating capacity:	40-120 m ²
Weight:	155 kg
Distance to combustible materials:	Back 350mm/Side 700mm/ Front 1000mm
Efficiency:	77,3%
Fine dust:	< 21 mg/m ³
Connection piece for Fresh Air:	intake Ø 100mm
Flue Pipe outlet diameter:	Ø150



A4 GAMA



Cleaning of glass



Fresh air connector



Three points closing

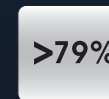

Efficiency

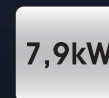

Heating power



Dimension of wood logs

Black, Serpentino

GREY



Serpentino



Yellow Sandstone



Silver Steel Sides



Vapnenac

TECHNICAL DATA

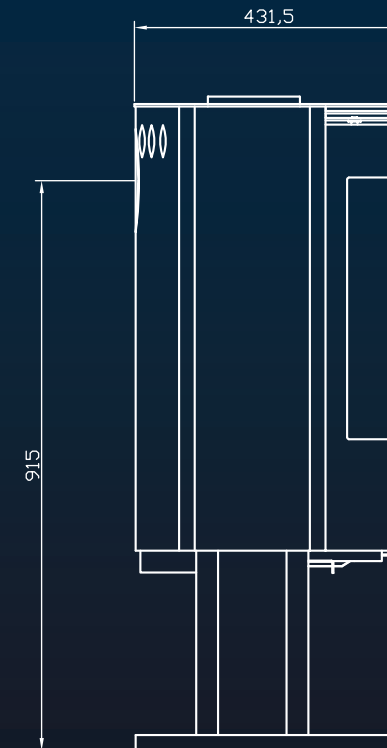
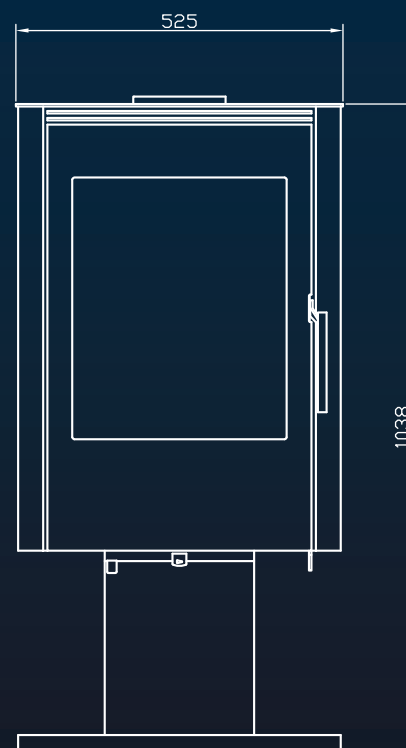

BLACK



Granit



Yellow Sandstone



Black Steel Sides



Vapnenac

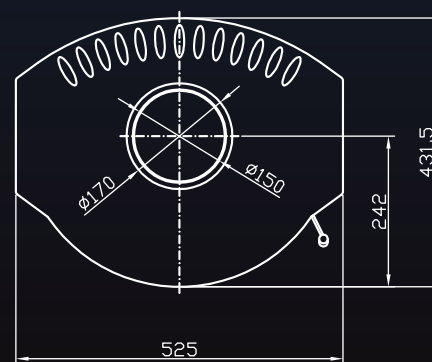

Nominal heating power:	7,9 kw
Room heating capacity:	40-120 m ²
Weight:	128 kg
Distance to combustible materials:	Back 200mm/Side 200mm/ Front 1000mm
Efficiency:	79,5%
Fine dust:	< 33 mg/m ³
Connection piece for Fresh Air:	intake Ø 100mm
Flue Pipe outlet diameter:	Ø150

A5 VERTIGO



Cleaning of glass



Fresh air connector



Three points closing

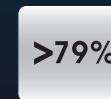

Efficiency

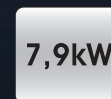

Heating power



Dimension of wood logs

Grey, Serpentino



GREY



Serpentino



Yellow Sandstone



Granit



Vapnenac

BLACK



Granit



Yellow Sandstone



Black Steel Sides



Vapnenac

TECHNICAL DATA

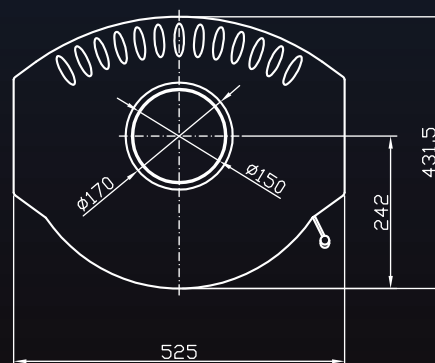
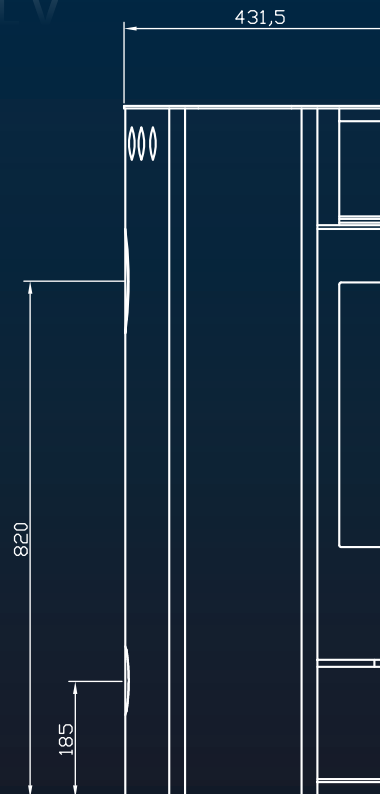
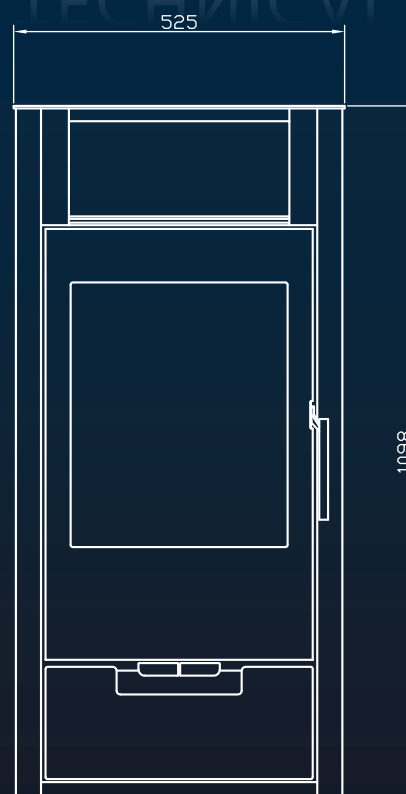

Nominal heating power:	7,9 kw
Room heating capacity:	40-120 m ²
Weight:	118 kg
Distance to combustible materials:	Back 200mm/Side 200mm/ Front 1000mm
Efficiency:	79,5%
Fine dust:	< 33 mg/m ³
Connection piece for Fresh Air:	intake \varnothing 100mm
Flue Pipe outlet diameter:	\varnothing 150

B2 Elipse SD



Cleaning of glass



Fresh air connector

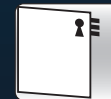

Three points closing

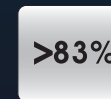

Efficiency

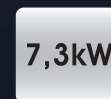

Heating power



Dimension of wood logs

Grey, Serpentino

GREY



Serpentino



Yellow Sandstone



Granit



Vapnenac

TECHNICAL DATA

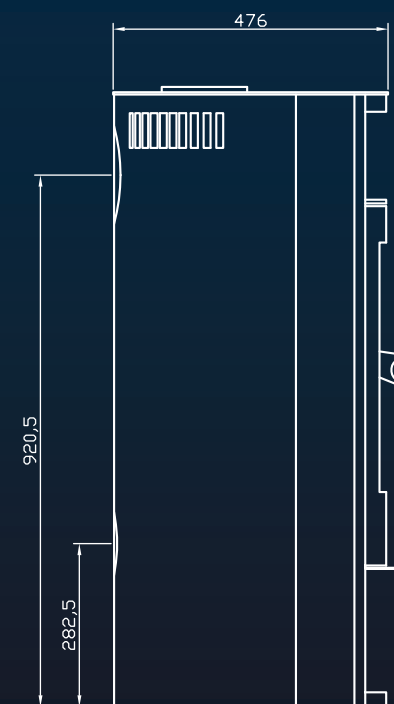
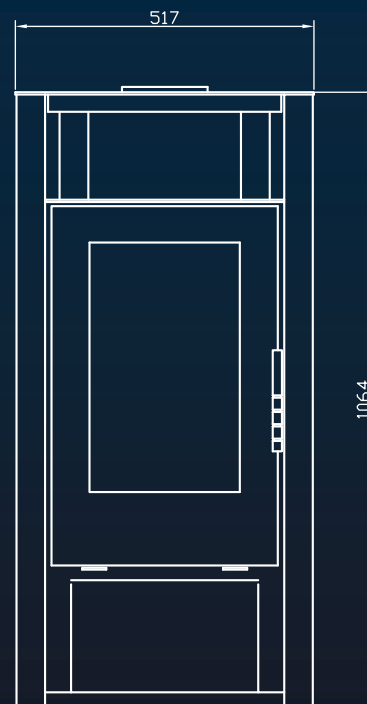

BLACK



Serpentino



Yellow Sandstone



Granit



Vapnenac

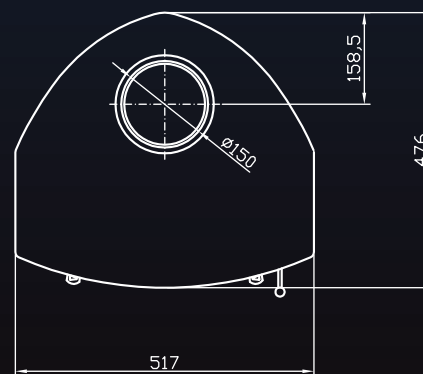

Nominal heating power:	7,3 kw
Room heating capacity:	40-120 m ²
Weight:	130 kg
Distance to combustible materials:	Back 250mm/Side 250mm/ Front 1100mm
Efficiency:	83%
Fine dust:	< 20 mg/m ³
Connection piece for Fresh Air:	intake Ø 100mm
Flue Pipe outlet diameter:	Ø150

B2 Elipse FG



Cleaning of glass



Fresh air connector



Three points closing

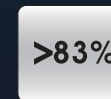

Efficiency

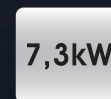

Heating power



Dimension of wood logs

Black, Yellow Sandstone

GREY



Serpentino



Yellow Sandstone

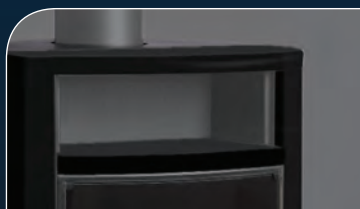

Granit



Vapnenac

TECHNICAL DATA

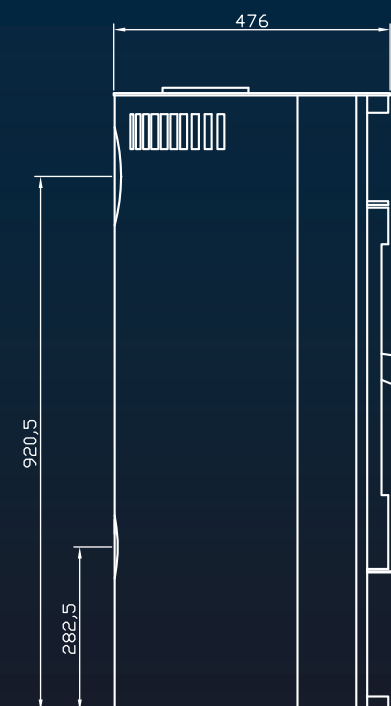
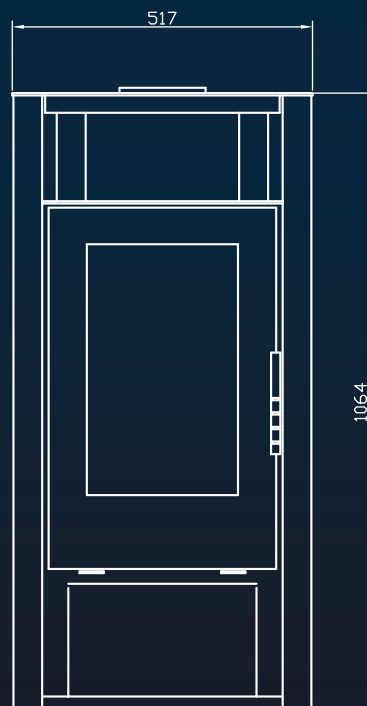

BLACK



Serpentino



Yellow Sandstone



Granit



Vapnenac

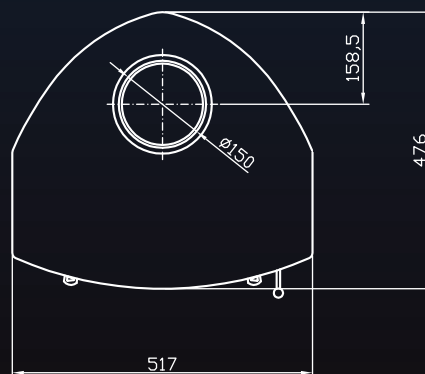

Nominal heating power:	7,3 kw
Room heating capacity:	40-120 m ²
Weight:	130 kg
Distance to combustible materials:	Back 250mm/Side 250mm/ Front 1100mm
Efficiency:	83%
Fine dust:	< 20 mg/m ³
Connection piece for Fresh Air:	intake Ø 100mm
Flue Pipe outlet diameter:	Ø150



C5 Algo SD



Cleaning of glass



Fresh air connector

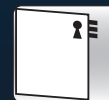

Three points closing

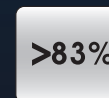

Efficiency

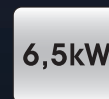

Heating power



Dimension of wood logs

Grey, Serpentino

GREY



Serpentino



Yellow Sandstone



Granit



Vapnenac

TECHNICAL DATA

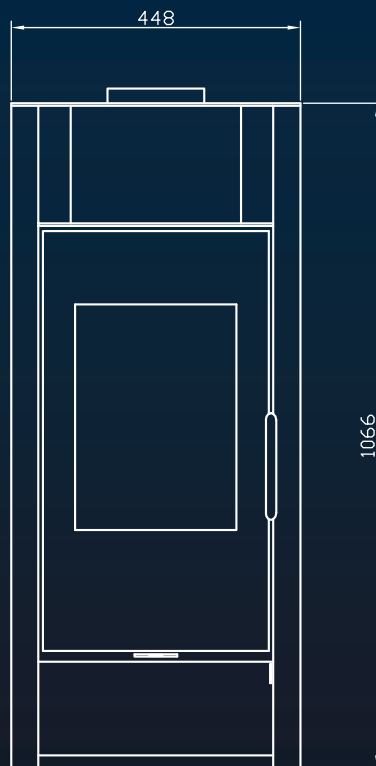

BLACK



Serpentino



Yellow Sandstone



Granit



Vapnenac

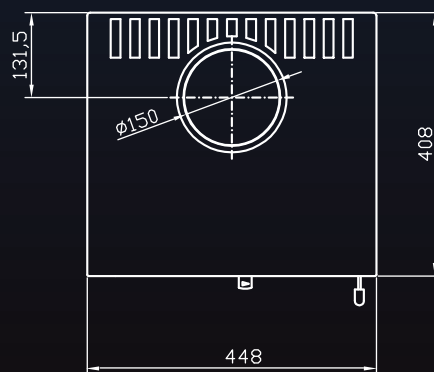

Nominal heating power:	6,5 kw
Room heating capacity:	20-100 m ²
Weight:	105 kg
Distance to combustible materials:	Back 350mm/Side 350mm/ Front 1000mm
Efficiency:	83,7%
Fine dust:	< 26 mg/m ³
Connection piece for Fresh Air:	intake Ø 100mm
Flue Pipe outlet diameter:	Ø150

C5 Visao FG



Cleaning of glass



Fresh air connector



Three points closing

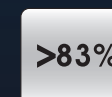

Efficiency

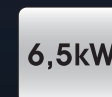

Heating power

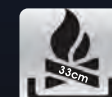

Dimension of wood logs

Black, Yellow Sandstone

GREY



Serpentino



Yellow Sandstone



Granit



Vapnenac

TECHNICAL DATA

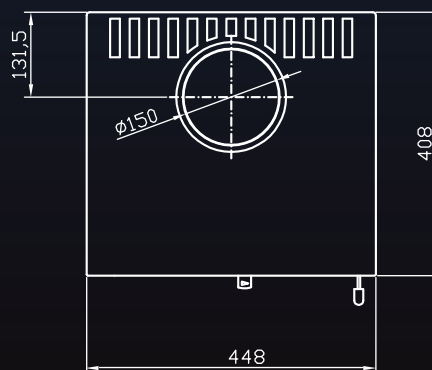
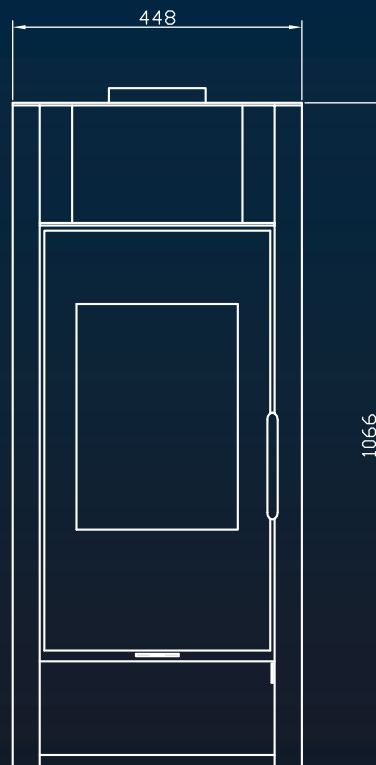

BLACK



Serpentino



Yellow Sandstone



Granit



Vapnenac

Nominal heating power:	6,5 kw
Room heating capacity:	20-100 m ²
Weight:	105 kg
Distance to combustible materials:	Back 350mm/Side 350mm/ Front 1000mm
Efficiency:	83%
Fine dust:	< 26 mg/m ³
Connection piece for Fresh Air:	intake Ø 100mm
Flue Pipe outlet diameter:	Ø150



D1 SOLO



Cleaning of glass



Fresh air connector

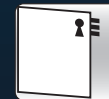

Three points closing

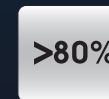

Efficiency



Heating power



Dimension of wood logs

Grey, Steel Sides

GREY



Serpentino



Yellow Sandstone



Grey Steel Sides



Vapnenac

TECHNICAL DATA

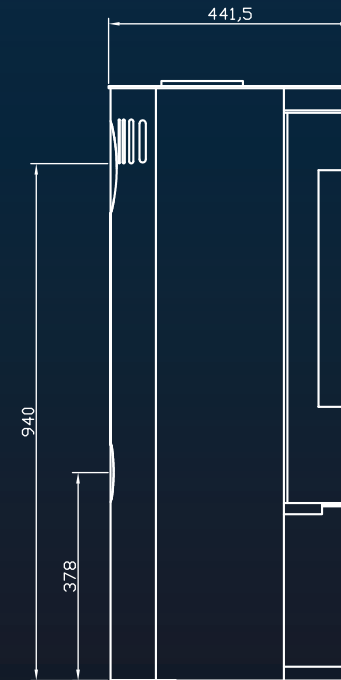
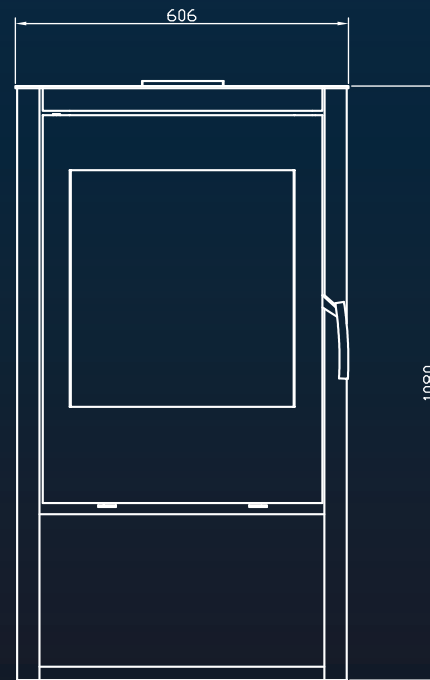

BLACK



Granit



Yellow Sandstone



Black Steel Sides



Vapnenac

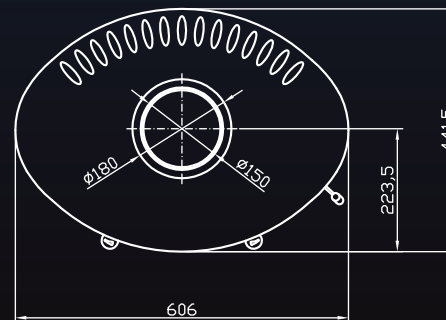

Nominal heating power:	7,0 kw
Room heating capacity:	40-120 m ²
Weight:	140 kg
Distance to combustible materials:	Back 200mm/Side 200mm/ Front 1350mm
Efficiency:	80,8%
Fine dust:	< 34 mg/m ³
Connection piece for Fresh Air:	intake Ø 100mm
Flue Pipe outlet diameter:	Ø150



D2 NEPTUN



Cleaning of glass



Fresh air connector

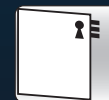

Three points closing

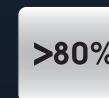

Efficiency



Heating power



Dimension of wood logs

Black, Granit

GREY



Serpentino



Yellow Sandstone



Silver Steel Sides



Vapnenac

TECHNICAL DATA

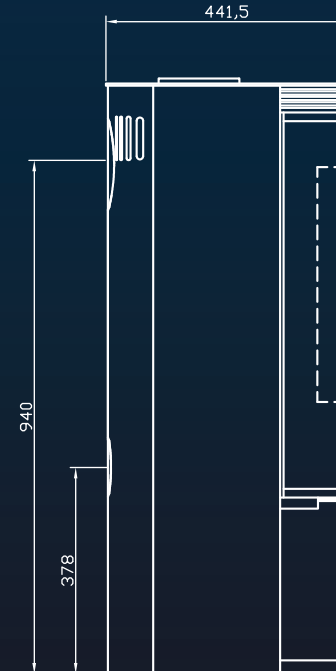
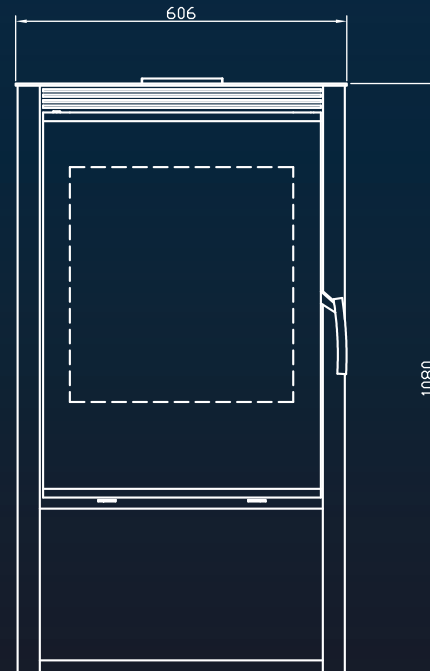

BLACK



Granit



Yellow Sandstone



Black Steel Sides



Vapnenac



Nominal heating power:	7,0 kw
Room heating capacity:	40-120 m ²
Weight:	140 kg
Distance to combustible materials:	Back 200mm/Side 200mm/ Front 1350mm
Efficiency:	80,8%
Fine dust:	< 34 mg/m ³
Connection piece for Fresh Air:	intake Ø 100mm
Flue Pipe outlet diameter:	Ø150



D4 SOLO

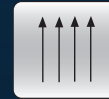

Cleaning of glass



Fresh air connector

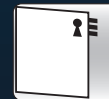

Three points closing

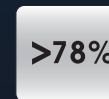

Efficiency



Heating power



Dimension of wood logs

Grey, Serpentino

GREY



Grey Steel Sides



Yellow Sandstone



Granit



Vapnenac

TECHNICAL DATA

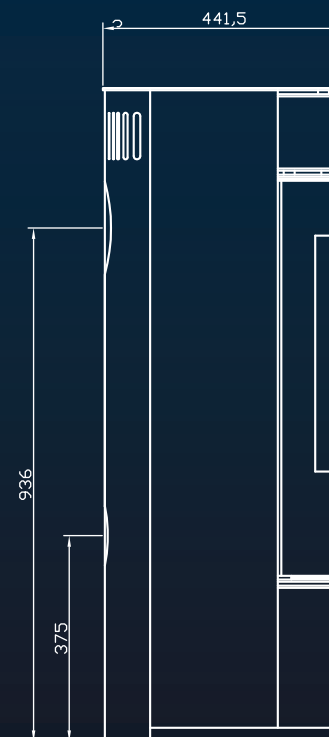
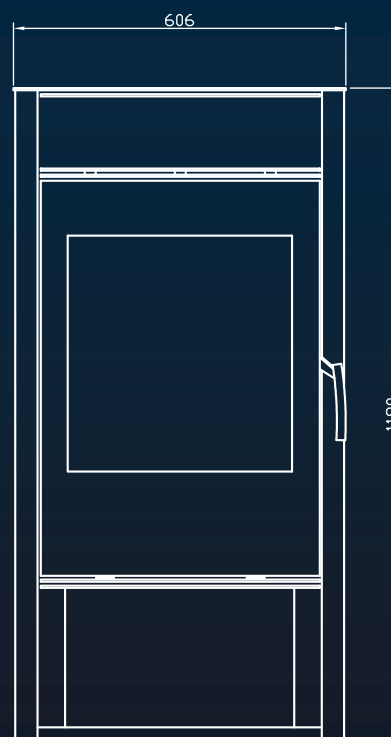

BLACK



Granit



Yellow Sandstone



Black Steel Sides



Vapnenac

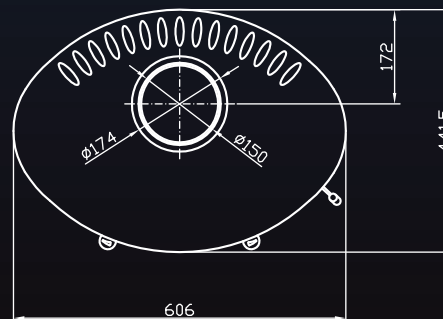

Nominal heating power:	7,0 kw
Room heating capacity:	40-120 m ²
Weight:	140 kg
Distance to combustible materials:	Back 200mm/Side 200mm/ Front 1350mm
Efficiency:	78,4%
Fine dust:	< 24 mg/m ³
Connection piece for Fresh Air:	intake Ø 100mm
Flue Pipe outlet diameter:	Ø150



D5 Solo SD



Heat tank

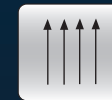

Cleaning of glass



Fresh air connector

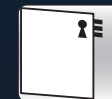

Three points closing

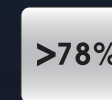

Efficiency



Heating power

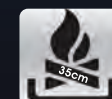

Dimension of wood logs

Grey, Serpentino

GREY



Grey Steel Sides



Yellow Sandstone



Granit



Vapnenac

TECHNICAL DATA

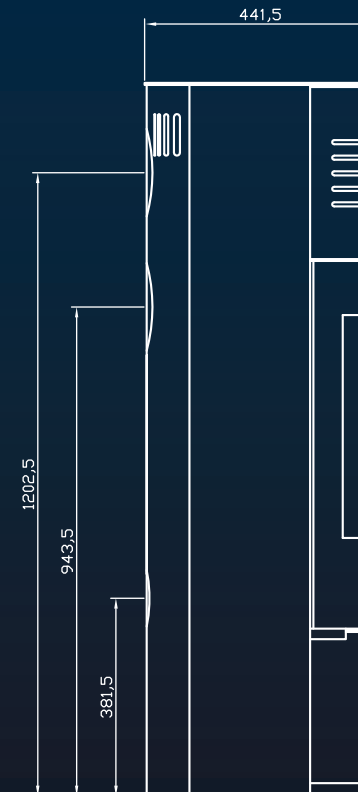

BLACK



Granit



Yellow Sandstone



Serpentino



Vapnenac

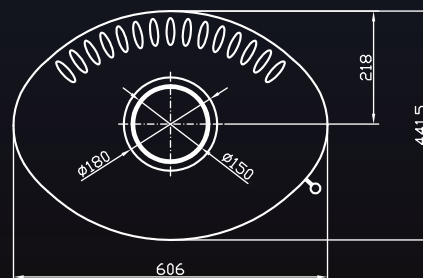

Nominal heating power:	7,0 kw
Room heating capacity:	40-120 m ²
Weight:	155 kg
Distance to combustible materials:	Back 200mm/Side 200mm/ Front 1350mm
Efficiency:	78,4%
Fine dust:	< 24 mg/m ³
Connection piece for Fresh Air:	intake Ø 100mm
Flue Pipe outlet diameter:	Ø150

D5 Solo FG



Heat tank



Cleaning of glass



Fresh air connector

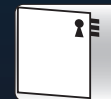

Three points closing

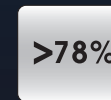

Efficiency



Heating power



Dimension of wood logs

Black, Steel Sides

GREY



Serpentino



Yellow Sandstone



Grey Steel Sides



Vapnenac

TECHNICAL DATA

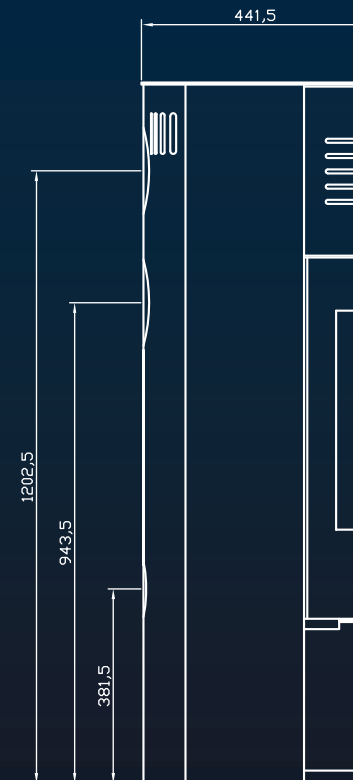

BLACK



Granit



Yellow Sandstone

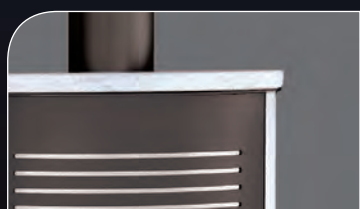

Serpentino



Vapnenac

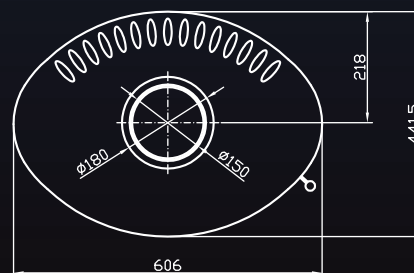

Nominal heating power:	7,0 kw
Room heating capacity:	40-120 m ²
Weight:	155 kg
Distance to combustible materials:	Back 200mm/Side 200mm/ Front 1350mm
Efficiency:	78,4%
Fine dust:	< 24 mg/m ³
Connection piece for Fresh Air:	intake Ø 100mm
Flue Pipe outlet diameter:	Ø150



D6 Solo SD



Rotating



Cleaning of glass

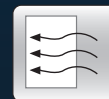

Fresh air connector



Three points closing

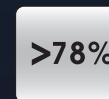

Efficiency



Heating power



Dimension of wood logs

Black, Serpentino

GREY

TECHNICAL DATA



Serpentino



Vapnenac



Grey Steel Sides



Granit

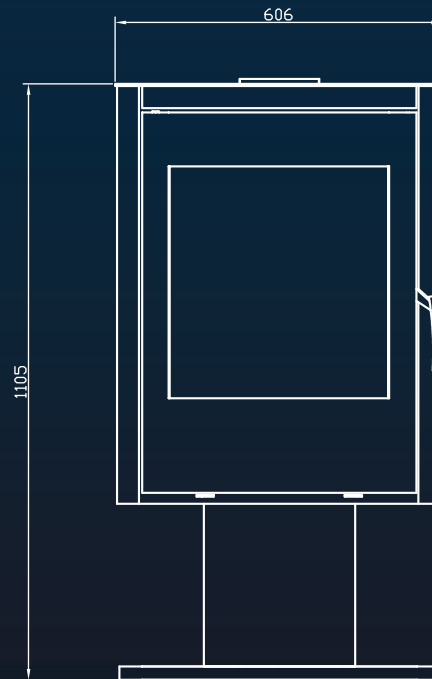

BLACK



Serpentino



Vapnenac



Black Steel Sides



Granit

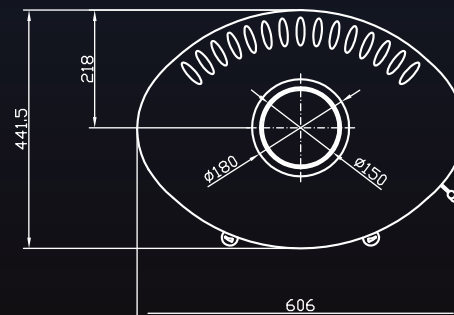

Nominal heating power:	7,0 kw
Room heating capacity:	40-120 m ²
Weight:	132 kg
Distance to combustible materials:	Back 200mm/Side 1100mm/ Front 1100mm
Efficiency:	78,4%
Fine dust:	< 24 mg/m ³
Connection piece for Fresh Air:	intake Ø 100mm
Flue Pipe outlet diameter:	Ø150



D6 Solo FG



Rotating



Cleaning of glass



Fresh air connector

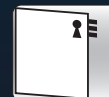

Three points closing

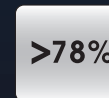

Efficiency



Heating power



Dimension of wood logs

Black, Coto

GREY

TECHNICAL DATA



Serpentino



Vapnenac



Grey Steel Sides



Granit

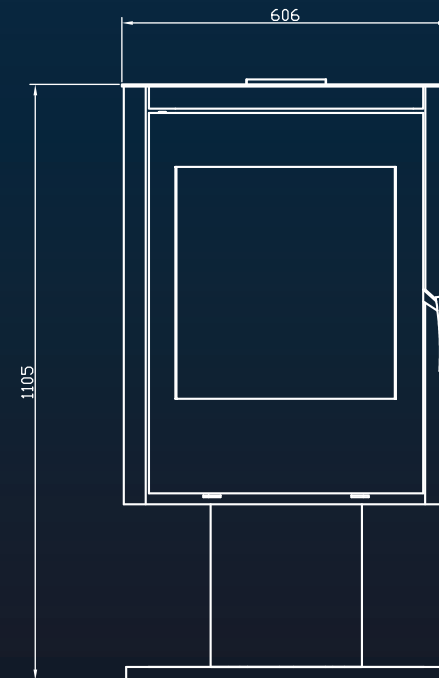

BLACK



Serpentino



Vapnenac



Black Steel Sides



Granit

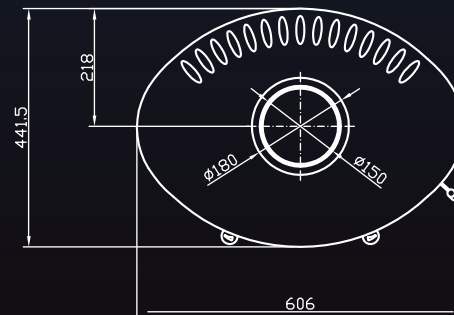

Nominal heating power:	7,0 kw
Room heating capacity:	40-120 m ²
Weight:	132 kg
Distance to combustible materials:	Back 200mm/Side 1100mm/ Front 1100mm
Efficiency:	78,4%
Fine dust:	< 24 mg/m ³
Connection piece for Fresh Air:	intake Ø 100mm
Flue Pipe outlet diameter:	Ø150



E WASSER



Central Heating



Fresh air connector

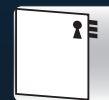

Three points closing

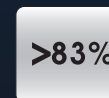

Efficiency

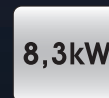

Heating power



Dimension of wood logs

Grey, Steel Sides

GREY

TECHNICAL DATA



Grey Steel Sides



Yellow Sandstone



Granit



Vapnenac

BLACK



Granit



Yellow Sandstone

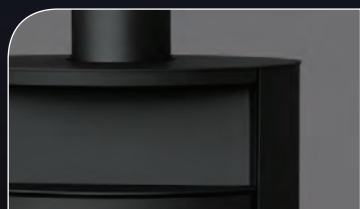

Black Steel Sides



Vapnenac

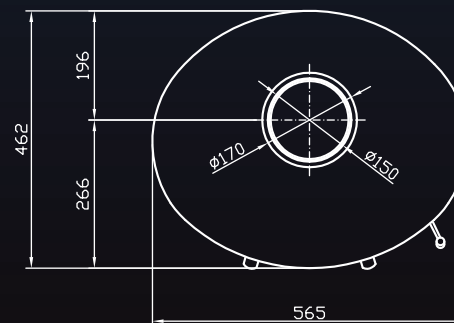
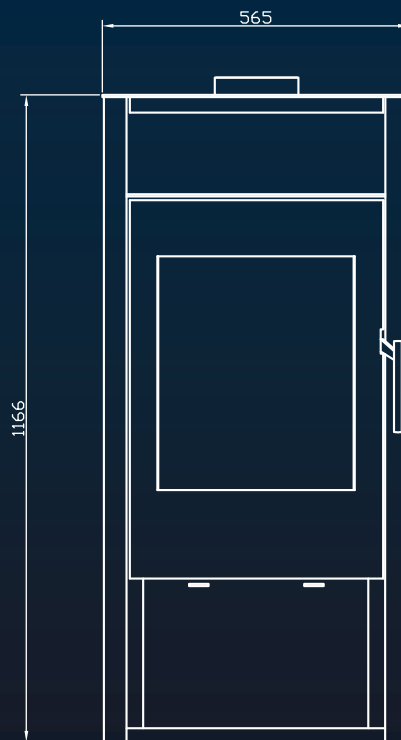

Nominal heating power:	8,3 kw
Room heating capacity:	40-140 m ²
Weight:	160 kg
Distance to combustible materials:	Back 150mm/Side 200mm/ Front 800mm
Efficiency:	83,4%
Fine dust:	< 20 mg/m ³
Connection piece for Fresh Air:	intake Ø 100mm
Flue Pipe outlet diameter:	Ø150



G1 Ronde SD



Cleaning of glass



Fresh air connector

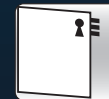

Self closing system

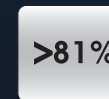

Efficiency

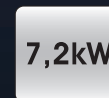

Heating power



Dimension of wood logs

Black, Steel Sides

GREY



Serpentino



Vapnenac



Silver Steel Sides



Yellow Sandstone

TECHNICAL DATA

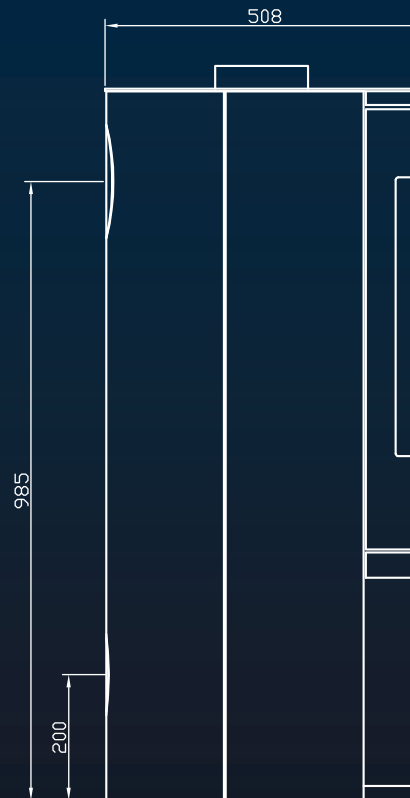
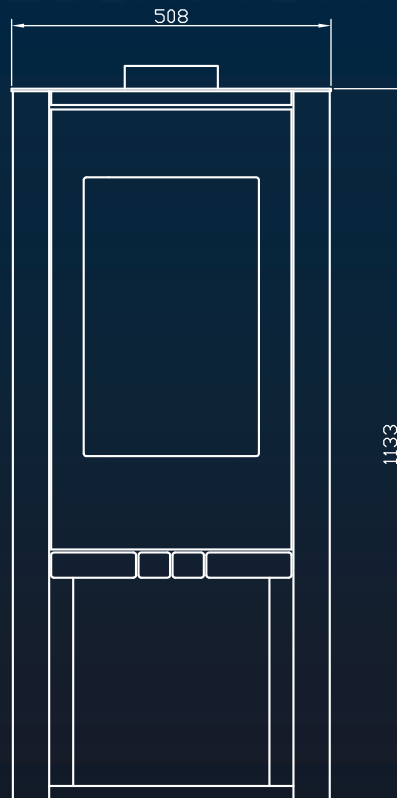

BLACK



Serpentino



Vapnenac



Black Steel Sides



Yellow Sandstone



Nominal heating power:	7,2 kw
Room heating capacity:	40-120 m ²
Weight:	130 kg
Distance to combustible materials:	Back 150mm/Side 250mm/ Front 900mm
Efficiency:	81,6%
Fine dust:	< 13 mg/m ³
Connection piece for Fresh Air:	intake Ø 100mm
Flue Pipe outlet diameter:	Ø150

G1 MODA FG



Cleaning of glass



Fresh air connector



Self closing system

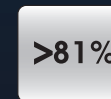

Efficiency

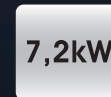

Heating power



Dimension of wood logs

Black, Red

GREY



Serpentino



Vapnenac



Grey Steel Sides



Yellow Sandstone

TECHNICAL DATA

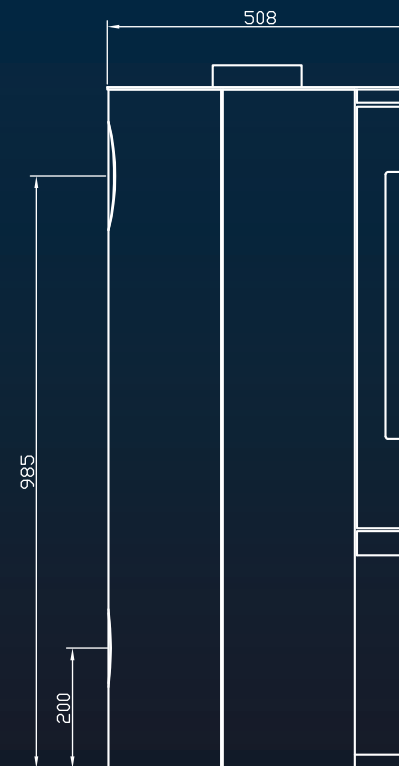
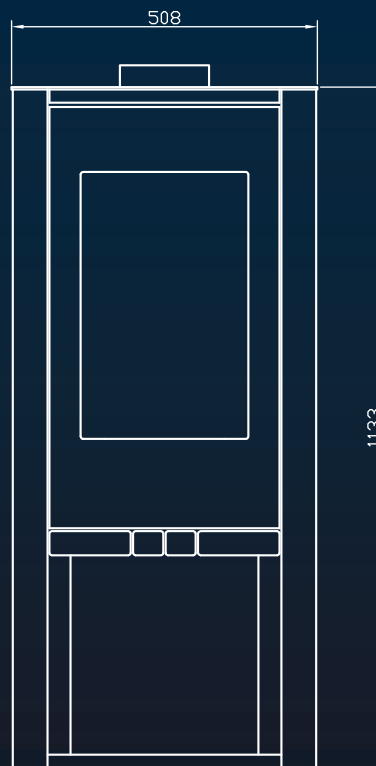

BLACK



Serpentino



Vapnenac



Black Steel Sides



Yellow Sandstone



Nominal heating power:	7,2 kw
Room heating capacity:	40-120 m ²
Weight:	132 kg
Distance to combustible materials:	Back 150mm/Side 250mm/ Front 900mm
Efficiency:	81,6%
Fine dust:	< 34 mg/m ³
Connection piece for Fresh Air:	intake Ø 100mm
Flue Pipe outlet diameter:	Ø150



G2 Suprema SD



Heat tank



Cleaning of glass



Fresh air connector

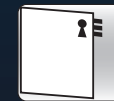

Self closing system

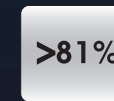

Efficiency

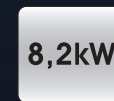

Heating power



Dimension of wood logs

Black, Yellow Sandstone

GREY



Serpentino



Yellow Sandstone



Grey Steel Sides



Vapnenac

TECHNICAL DATA

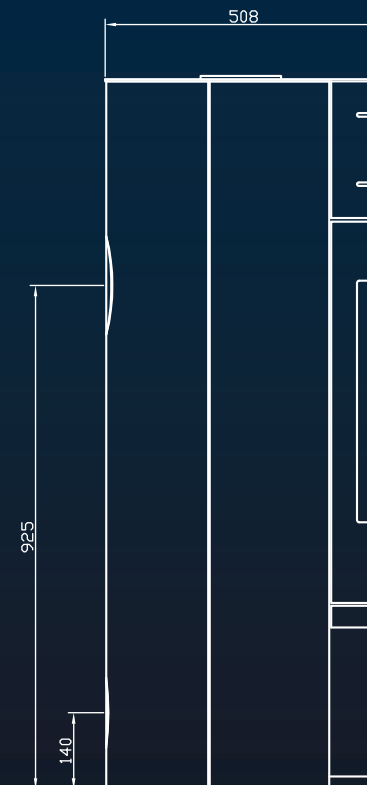
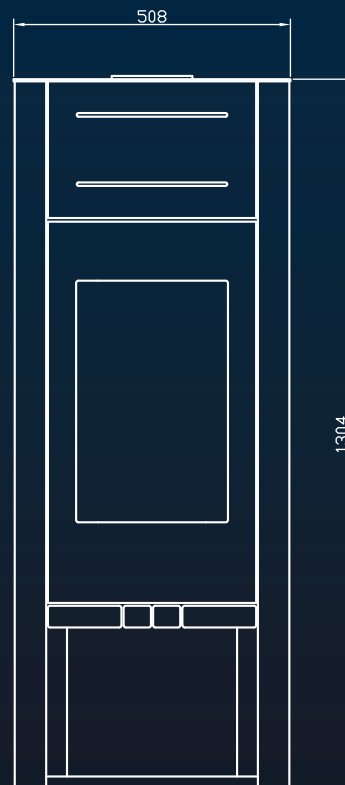

BLACK



Granit



Serpentino



Black Steel Sides



Vapnenac



Nominal heating power:	8,2 kw
Room heating capacity:	40-140 m ²
Weight:	138 kg
Distance to combustible materials:	Back 200mm/Side 200mm/ Front 800mm
Efficiency:	81,5%
Fine dust:	< 16 mg/m ³
Connection piece for Fresh Air:	intake Ø 100mm
Flue Pipe outlet diameter:	Ø150

G2 Suprema FG



Heat tank



Cleaning of glass



Fresh air connector



Self closing system

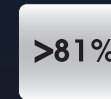

Efficiency

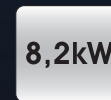

Heating power



Dimension of wood logs

Black, Serpentino

GREY



Serpentino



Yellow Sandstone



Grey Steel Sides



Vapnenac

TECHNICAL DATA

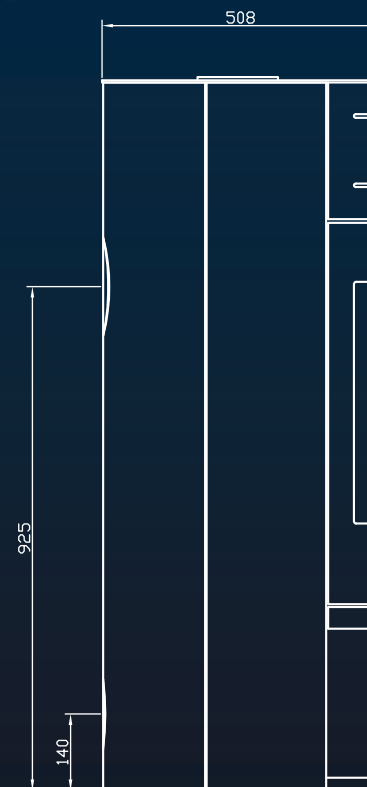
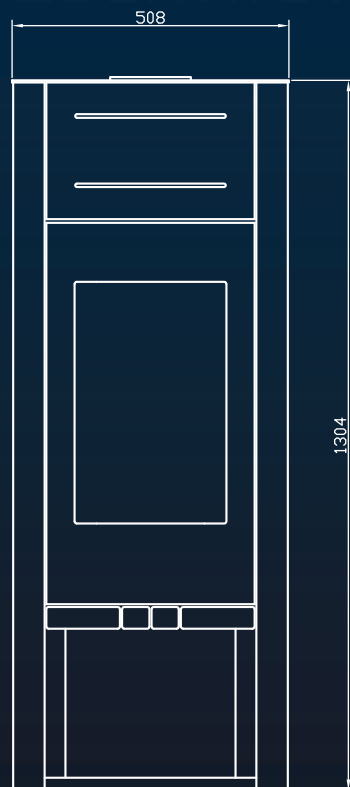

BLACK



Granit



Yellow Sandstone



Black Steel Sides



Vapnenac



Nominal heating power:	8,2 kw
Room heating capacity:	40-140 m ²
Weight:	140 kg
Distance to combustible materials:	Back 200mm/Side 200mm/ Front 800mm
Efficiency:	81,5%
Fine dust:	< 16 mg/m ³
Connection piece for Fresh Air:	intake Ø 100mm
Flue Pipe outlet diameter:	Ø150



G3 Vitrum



Cleaning of glass



Fresh air connector

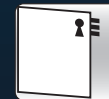

Self closing system

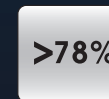

Efficiency

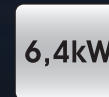

Heating power



Dimension of wood logs

Black, Steel Sides

TECHNICAL DATA



Grey, Steel Sides

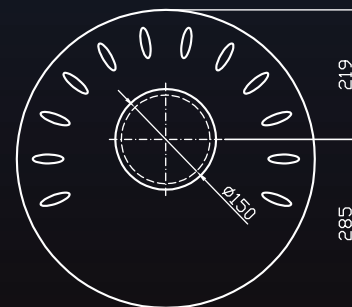
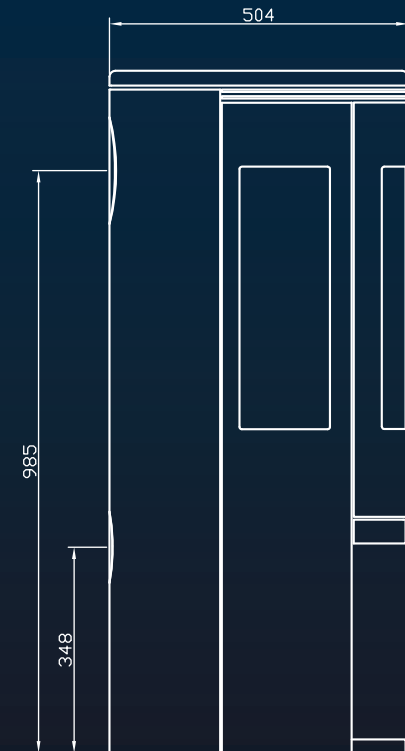
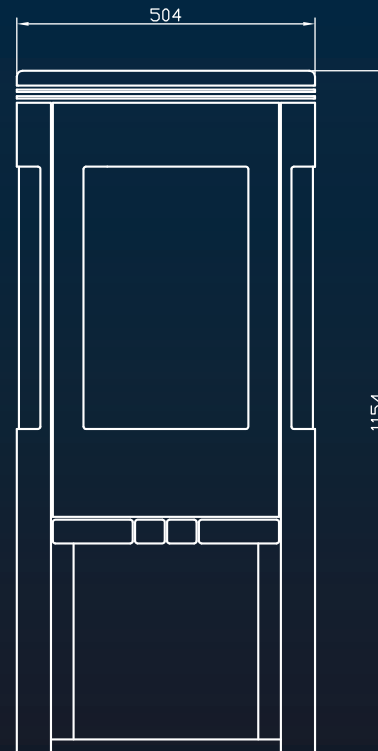

Nominal heating power:	6,4 kw
Room heating capacity:	40-120 m ²
Weight:	128 kg
Distance to combustible materials:	Back 120mm/Side 640mm/ Front 800mm
Efficiency:	78,0%
Fine dust:	< 22 mg/m ³
Connection piece for Fresh Air:	intake Ø 100mm
Flue Pipe outlet diameter:	Ø150



H1 Rustico SD



Cleaning of glass



Fresh air connector



Three points closing

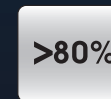

Efficiency

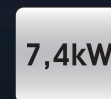

Heating power



Dimension of wood logs

Grey, Steel Sides

GREY



Serpentino



Yellow Sandstone



Silver Steel Sides



Vapnenac

TECHNICAL DATA

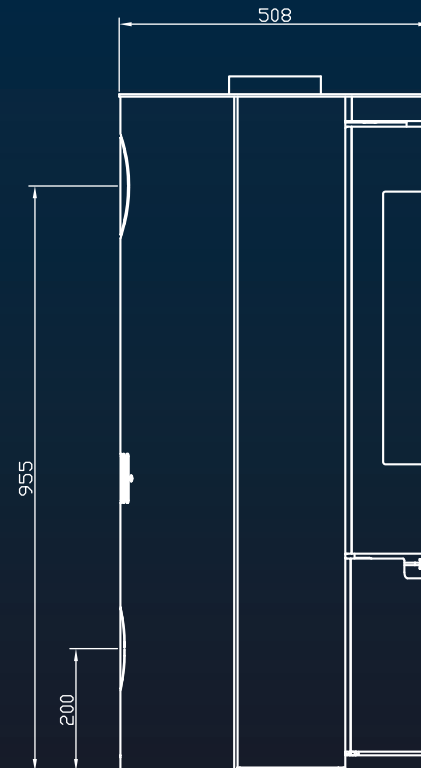
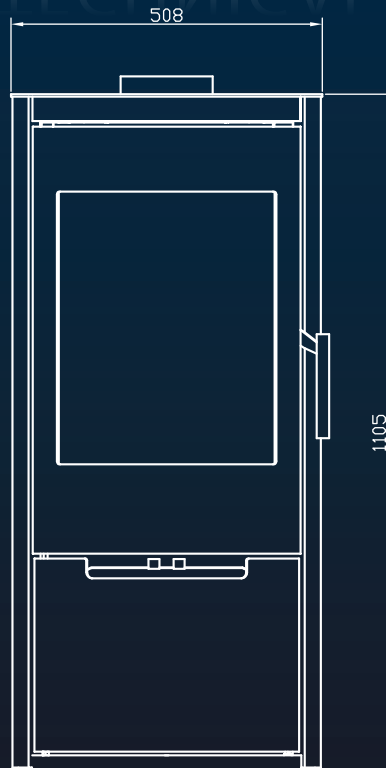

BLACK



Serpentino



Yellow Sandstone



Black Steel Sides



Granit



Nominal heating power:	7,4 kw
Room heating capacity:	40-120 m ²
Weight:	105 kg
Distance to combustible materials:	Back 150mm/Side 150mm/ Front 800mm
Efficiency:	80,6%
Fine dust:	< 14 mg/m ³
Connection piece for Fresh Air:	intake Ø 100mm
Flue Pipe outlet diameter:	Ø150



H1 Gato FG



Cleaning of glass



Fresh air connector

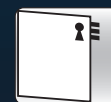

Three points closing

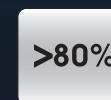

Efficiency

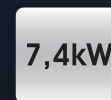

Heating power



Dimension of wood logs

Black, Yapnenac

GREY

TECHNICAL DATA



Serpentino



Yellow Sandstone



Silver Steel Sides



Vapnenac

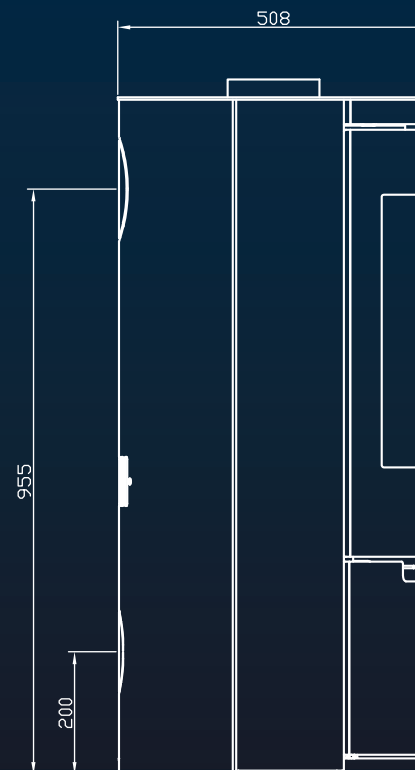
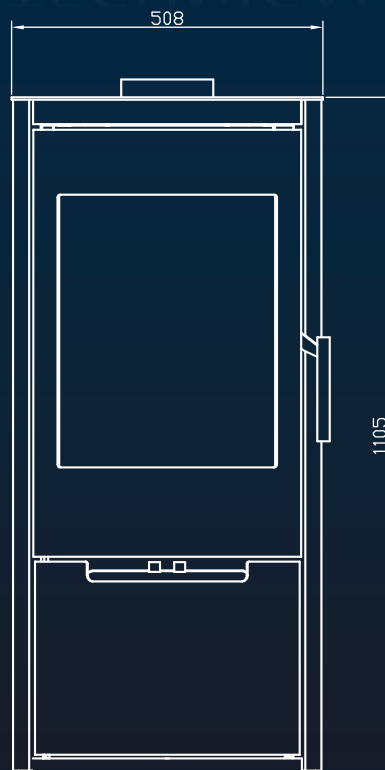

BLACK



Serpentino



Yellow Sandstone



Black Steel Sides



Granit



Nominal heating power:	7,4 kw
Room heating capacity:	40-120 m ²
Weight:	106 kg
Distance to combustible materials:	Back 150mm/Side 150mm/ Front 800mm
Efficiency:	80,6%
Fine dust:	< 14 mg/m ³
Connection piece for Fresh Air:	intake Ø 100mm
Flue Pipe outlet diameter:	Ø150



R1 Onyx



Cleaning of glass



Fresh air connector

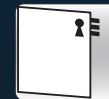

Three points closing

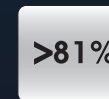

Efficiency

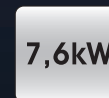

Heating power



Dimension of wood logs

Grey, Silver Sides

TECHNICAL DATA



Grey, Serpentino

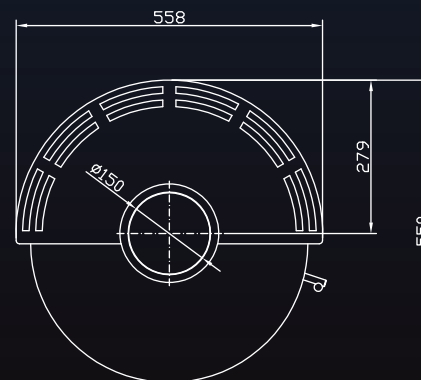
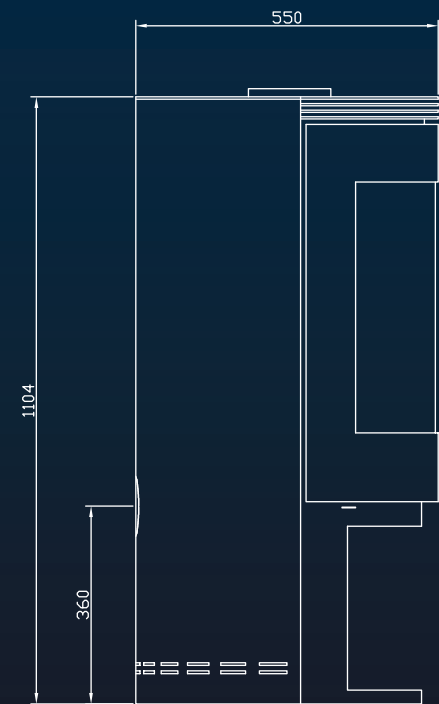
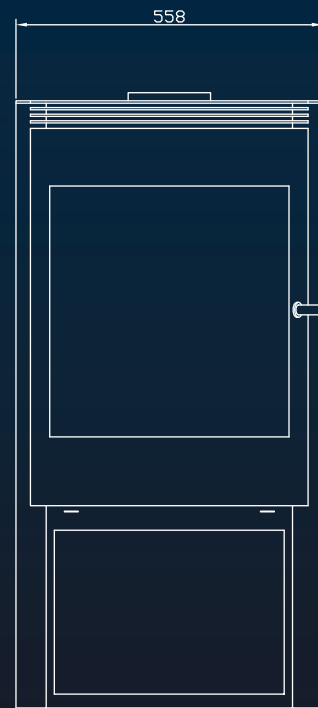

Nominal heating power:	7,6 kw
Room heating capacity:	40-120 m ²
Weight:	150 kg
Distance to combustible materials:	Back 100mm/Side 200mm/ Front 800mm
Efficiency:	81,2%
Fine dust:	< 25 mg/m ³
Connection piece for Fresh Air:	intake Ø 100mm
Flue Pipe outlet diameter:	Ø150



R3 Fenix



Cleaning of glass



Fresh air connector

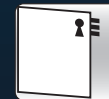

Three points closing

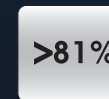

Efficiency

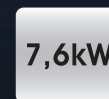

Heating power



Dimension of wood logs

Grey, Silver Sides

TECHNICAL DATA



Grey, Serpentino

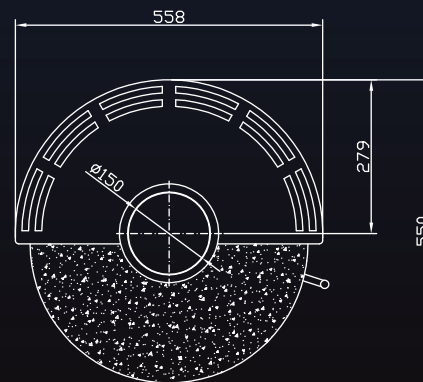
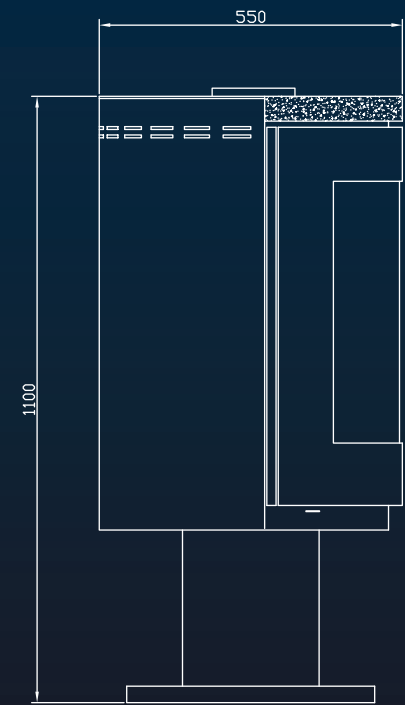
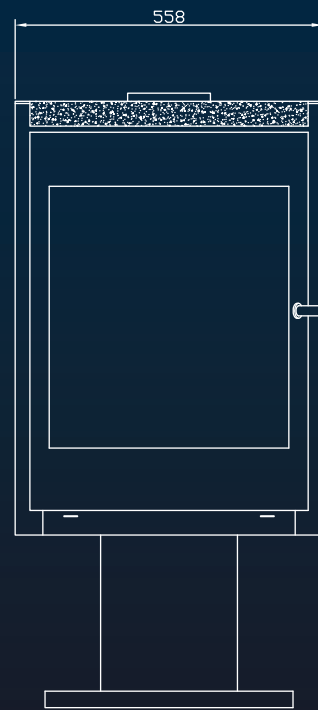

Nominal heating power:	7,6 kw
Room heating capacity:	40-120 m ²
Weight:	150 kg
Distance to combustible materials:	Back 100mm/Side 800mm/ Front 800mm
Efficiency:	81,2%
Fine dust:	< 25 mg/m ³
Connection piece for Fresh Air:	intake Ø 100mm
Flue Pipe outlet diameter:	Ø150



Color emajl d.o.o.
Alaginci 87A
HR - 34000 Požega
CROATIA
www.color.hr / team@color.hr



Color Fire GMBH
Brückenstr. 16
DE - 57629 Höchstenbach
GERMANY
www.color-emajl.eu / team@color.hr